

KENWOOD

Bluetooth HANDS FREE BOX

KCA-BT100

INSTRUCTION MANUAL

Kenwood Corporation



Contents

Before Use

Safety Precautions	3
---------------------------	----------

Notes	4
--------------	----------

Setting up the Bluetooth Function	5
------------------------------------------	----------

Before Use	5
Registering Your Cell-Phone	5
Downloading the Phone Book	5

For Monitor receiver (DDX series)

Hands-Free Unit Control	12
--------------------------------	-----------

Hands-Free Control screen	12
Remote Controller	13
Key Operation	13
When Called	14
When Dialing	14
Quick Dialing	14
Calling by Phone Book	15
Redialing	16
Setting up the Hands-Free Phone	16
Selecting a Hands-Free Phone	17
Deleting the Hands-Free Phone	17

Accessories/ Installation Procedure	18
------------------------------------------------	-----------

Connection	19
-------------------	-----------

Installation	20
---------------------	-----------

Troubleshooting Guide	21
------------------------------	-----------

Specifications	21
-----------------------	-----------

For Audio receiver

General Features	6
-------------------------	----------

Answering a Phone Call	6
Switching to the Private Mode	6
Clearing the Disconnection Message	6
Adjusting the Voice Volume during a Call	6
Disconnecting a Call	6
Switching between Display Modes	6

Dialing Method	7
-----------------------	----------

Selecting the Dialing Mode	7
Making a Call by Entering a Phone Number	7
Dialing by Using the Quick Dialing Function	7
Registering to the Preset Dial Number List	8
Dialing by Using the Phone Book	8
Dialing by Using the Outgoing Call List	8
Dialing by Using the Incoming Call List	9

Remote Control	9
-----------------------	----------

Functions of the buttons	9
--------------------------	---

Menu System	10
--------------------	-----------

Menu System	10
Selecting the Cell-Phone You Wish to Connect	10
Deleting a Registered Cell-Phone	10
Displaying the Cell-Phone Status	10
Setting the Time Interval for Automatic Answer	11
Setting up the Voice Output Speakers	11
Setting the Beep of the Incoming Call	11

Safety Precautions

▲WARNING

To prevent injury or fire, take the following precautions:

- To prevent a short circuit, never put or leave any metallic objects (such as coins or metal tools) inside the unit.
- Mounting and wiring this product requires skills and experience. For safety's sake, leave the mounting and wiring work to professionals.

▲CAUTION

To prevent damage to the machine, take the following precautions:

- Do not install the unit in a spot exposed to direct sunlight or excessive heat or humidity. Also avoid places with too much dust or the possibility of water splashing.

The Bluetooth word mark and logos are owned by the Bluetooth SIG, Inc. and any use of such marks by Kenwood Corporation is under license. Other trademarks and trade names are those of their respective owners.

Notes

- If you experience problems during installation, consult your Kenwood dealer.
- When you purchase optional accessories, check with your Kenwood dealer to make sure that they work with your model and in your area.
- The illustrations of the display and the panel appearing in this manual are examples used to explain more clearly how the controls are used. Therefore, what appears on the display in the illustrations may differ from what appears on the display on the actual equipment, and some of the illustrations on the display may be inapplicable.

Kenwood Receivers available for this unit

The receiver units that can be used with KCA-BT100 are as follows: (As of September 2006)

Audio receiver

DPX-MP2090U*, DPX-MP7090U, KDC-MP5033U*, KDC-X7533U*, KDC-X9533U, KDV-MP6333*, KDV-MP6433*

Monitor receiver

DDX6039

For details on the compatible receivers to be released in the future, access the following URL:

<http://www.kenwood.com/bt/bt100/>



- *: Set the display character conversion function switch to "2". For more details, see <Display Character Conversion Function> (page 18).

About the Remote Controller

The audio receiver requires a remote controller with numeric buttons to enter phone numbers directly.

To make a call using the remote controller, the  button must be provided on the remote controller.

For more details, access the following URL:

<http://www.kenwood.com/bt/bt100/>



- You cannot use a remote controller depending on the type of your control unit.

About the Cell-Phone

This unit conforms to the following Bluetooth specifications:

Version	Bluetooth Standard Ver. 1.2
Profile	HFP (Hands Free Profile) OPP (Object Push Profile)

For the cell-phones verified for compatibility, access the following URL:

<http://www.kenwood.com/bt/bt100/>



- The units supporting the Bluetooth function have been certified for conformity with the Bluetooth Standard following the procedure prescribed by Bluetooth SIG. However, it may be impossible for such units to communicate with your cell-phone depending on its type.
- HFP is a profile used to make a hands-free call.
- OPP is a profile used to transfer data such as a phone book between units.

Setting up the Bluetooth Function

Before Use

- You need to register your cell-phone before using it with this unit. For more details, see <Registering Your Cell-Phone> (page 5).
- If you have registered two or more cell-phones, you need to select one of them. For more details, see <Selecting the Cell-Phone You Wish to Connect> (page 10) or <Selecting a Hands-Free Phone> (page 17).
- To use the Phone Book, it must be downloaded to this unit in advance. For details, see <Downloading the Phone Book> (page 5).
- You can set up the voice output speaker. For more details, see <Setting up the Voice Output Speakers> (page 11) or <Setting up the Hands-Free Phone> (page 16).

Registering Your Cell-Phone

To make your cell-phone usable with this unit, you need to register it (pairing). You can register up to five cell-phones to this unit.

1 Turn on the control unit.

2 Start cell-phone registration on the cell-phone

By operating the cell-phone, carry out hands-free phone registration (pairing). Select "KCA-BT100" from the list of connected units.

3 Enter a path key

Enter "1234" as a path key.

Check that registration is complete on the cell-phone.

4 By operating the cell-phone, start hands-free connection.



- For how to operate the cell-phone, refer to the Instruction Manual that comes with your cell-phone.
- You can register up to five cell-phones. Registering the sixth cell-phone will delete the cell-phone registered most previously.
- You cannot register a cell-phone when another cell-phone is in the hands-free connection status. End the hands-free connection, and then register a new cell-phone.
- If two or more "KCA-BT100" are displayed in the list of connected units, another "KCA-BT100" is probably used nearby. Move your car, and then check that only one "KCA-BT100" is displayed.

Downloading the Phone Book

Download the phone book data from the cell-phone to this unit so that you can use the Phone Book of this unit.

1 By operating the cell-phone, end the hands-free connection.

2 By operating the cell-phone, send the phone book data to this unit

By operating the cell-phone, download the phone book data to this unit.

During downloading:

"Downloading", "DOWNLOAD", or "Now Downloading..." is displayed.

After completion of downloading (for Audio receiver):

"Complete", "Completed", or "COMPLETE" is displayed.

3 By operating the cell-phone, start the hands-free connection.

To clear the downloading completion message (for Audio receiver):

Press any button.



- For how to operate the cell-phone, refer to the Instruction Manual that comes with your cell-phone.
- Up to 300 phone numbers can be registered for each registered cell-phone.
- Up to 32 digits can be registered for each phone number along with up to 40 characters representing a name.
- Depending on the type of your cell-phone, the following restrictions are placed:
 - The phone book data cannot be downloaded normally.
 - Characters in the Phone Book are garbled.
 - The phone book data cannot be downloaded normally if it contains images. It may take several hours to a full day to download the phone book depending on the total image size.
- To cancel downloading of the phone book data, operate the cell-phone.

Answering a Phone Call

When "CALL" or "Call" is displayed, "(Calling party name)" or "(Phone number)" is also displayed.

Press the [AUDIO] button or one of [1] – [6] buttons.

Rejecting an Incoming Call

Press the [ATT] button for at least 1 second.



- You can set up the unit so that the incoming call is received after lapse of a predetermined time. For more details, see <Setting the Time Interval for Automatic Answer> (page 11).
- Inserting a disc such as a CD will disconnect your call.
- Setting the cell-phone in the private mode can disable the hands-free function.
- When a call without caller ID arrives, "No Name No Number", "No Number", or "NO-NMBER" is displayed.
- The name of the calling party is displayed if it has already been registered in the Phone Book.

Switching to the Private Mode

You can switch between the private mode (talking directly on the cell-phone) and the hands-free mode.

Press the Control knob ([▶II]).

Talk modes are switched as follows:

Display	Talk mode
"Private"/ "PRIVATE"/ "PV TALK"	Private talk
"Handsfree"/ – / "HF TALK"	Hands-free talk



- Depending on the type of your cell-phone, switching to the private talk mode may select the source that was used before commencing the hands-free connection. If this happens, the source cannot be switched back to the hands-free talk mode by operating this unit. Operate your cell-phone to return to the hands-free talk mode.

Clearing the Disconnection Message

You can clear the message displayed after disconnection of the cell-phone.

Press the [ATT] button for at least 1 second.

"Disconnect" or "DISONCT" disappears.



- It may take some time before the disconnected cell-phone is reconnected.

Adjusting the Voice Volume during a Call

You can adjust the voice volume during a call.

Turn the [VOL] knob.



- The volume adjusted during the current call will be effective for the next and subsequent calls.
- Increasing the volume excessively is more likely to produce echo. If echo is produced, turn down the volume as low as possible. Echo increases in proportion to the volume.

Disconnecting a Call

Press the [SRC] button.



- You can also press the [ATT] button for at least 1 second to end a call.

Switching between Display Modes

You can switch between the Phone Book and the Call List.

Press the [DISP]/ [AUTO]/ [TI] button.

If the [DISP] button is not provided, press the [AUTO] or [TI] button.

For the Audio receiver with Multi-function Key System:

Press the [AUTO]/ [TI] button.

Pressing this button toggles between the name list and the phone number list.

Scrolling the Display

You can scroll through the list of phone numbers or names. For the operation method, refer to <Text/ Title Scroll> in the Instruction Manual that comes with the control unit.



- With the control unit on which only the name of the calling party is displayed when receiving a call or quick dialing, you can switch to the phone number display mode by performing the above operation.
- Depending on the type of your control unit, the following restrictions are placed.
 - Up to 19 characters can be displayed.
 - The # letter cannot be displayed, or "■" (all segments are lit) is displayed for #.
 - You cannot switch between display modes.

Selecting the Dialing Mode

You can dial in five different ways.

1 Enter the dialing method selection mode

Press the [ATT] button for at least 1 second.

"DIAL" or "N-DIAL" is displayed.

2 Select a dialing method

Press the Control knob (▶||II).

Pressing this knob toggles between the following dialing methods:

For the Audio receiver with Multi-function Key System:

1 Press the [NEXT] button.

Select the key function section.

2 Press the [1] ("DIAL") – [4] ("IN-C") button.

Display	Multi key	Dialing method
"DIAL"/ "N-DIAL"	[1] ("DIAL")	Dial by entering a phone number. (page 7)
"INITIAL"/ "PH-BOOK1"	[2] ("PHBK")*	Dial by searching for the initial in the Phone Book (page 8)
"PH.BOOK"/ "PH-BOOK2"	[2] ("PHBK")*	Dial by searching the Phone Book in the alphabetical order. (page 8)
"OUT"/ "OUT-CALL"	[3] ("OUT-C")	Dial by using the outgoing call list. (page 8)
"IN"/ "IN-CALL"	[4] ("IN-C")	Dial by using the incoming call list. (page 9)

3 Exit the dialing method selection mode

Press the [ATT] button for at least 1 second.



- To use the Phone Book, it must have been downloaded from the cell-phone. For more details, see <Downloading the Phone Book> (page 5).
- The outgoing call list and the incoming call list are the lists of calls originated from and received at this unit. They are not the ones stored in the cell-phone memory.
- * With the Multi-function Key System, pressing the [2] ("PHBK") button switches between the Phone Book search methods.

Function of remote controller

Making a Call by Entering a Phone Number

You can make a call by entering a phone number.

1 Enter the number dial mode

Select the "DIAL" or "N-DIAL" display.

Refer to <Selecting the Dialing Mode> (page 7).

2 Enter a phone number

Press the number ([1] – [0]), #([FM]), *([AM]), or +([▶▶]) button on the remote controller.

3 Make a call

Press the [DIRECT] button on the remote controller.

"CALL" or "Call" is displayed.

To erase the entered phone number digit by digit:

Press the [◀◀] button on the remote controller.



- You can input max 32 digits.
- Depending on the type of your control unit, "■" (all segments are lit) is displayed for #.

Dialing by Using the Quick Dialing Function

You can dial by calling the phone number registered to the preset dial number list. For how to preset a phone number, refer to <Registering to the Preset Dial Number List> (page 8).

1 Enter the number dialing mode

Select the "DIAL" or "N-DIAL" display.

Refer to <Selecting the Dialing Mode> (page 7).

2 Select the button corresponding to the preset dial number

Press the [1] – [3] button.

"Preset #" or "PRESET #" is displayed.

For the Audio receiver with Multi-function Key System:

1 Press the [NEXT] button.

Select the key function section.

2 Press the [1] ("1") – [3] ("3") button.

"DIAL #" is displayed.

3 Make a call

Press the Control knob (▶||II) for at least 1 second.

"CALL" or "Call" is displayed.



- If the desired number is not registered to the preset dial number list, "No Name No Number", "No Number", or "NO-NUMBER" is displayed.

Registering to the Preset Dial Number List

You can register up to 3 phone numbers for quick dialing.

1 Enter the phone number you wish to register

Enter the phone number with reference to the following:

- <Making a Call by Entering a Phone Number> (page 7)
- <Dialing by Using the Phone Book> (page 8)
- <Dialing by Using the Outgoing Call List> (page 8)
- <Dialing by Using the Incoming Call List> (page 9)

2 Select the button you wish to register

Press the [1] – [3] button for at least 2 seconds.

For the Audio receiver with Multi-function Key System:

1 Press the [NEXT] button.

Select the key function section.

2 Press the [1] ("1"/ "MEM.1") – [3] ("3"/ "MEM.3") button for at least 2 seconds.

"Memory" or "MEMORY" display blinks 1 time.

3 Exit the dialing method selection mode

Press the [ATT] button for at least 1 second.

Dialing by Using the Phone Book

You can dial by using the downloaded Phone Book.

1 Enter the Phone Book mode

Select the "INITIAL", "PH-BOOK1", "PH.BOOK", or "PH-BOOK2" display.

Refer to <Selecting the Dialing Mode> (page 7).

If you have selected, "PH.BOOK" or "PH-BOOK2", proceed to step 4.

For the Audio receiver with Multi-function Key System:

Press the [2] ("PHBK") button.

Pressing this button toggles between the following search methods:

Display	Search method
"INITIAL"/ "PH-BOOK1"	Search by the initial.
"PH.BOOK"/ "PH-BOOK2"	Search in the alphabetical order.
"PH-BOOK2"	Proceed to step 4.

2 Select the initial to be searched for

Push the Control knob towards [◀◀], [▶▶], [FM] or [AM].

Move the cursor to the initial to be searched for.

Knob	Operation
[◀◀]/ [▶▶]	Move to the next character.
[FM]/ [AM]	Move to the next row.

3 Determine the selected initial

Press the Control knob ([▶▶]) for at least 1 second.

4 Select the name

Push the Control knob towards [FM], [AM], [◀◀] or [▶▶].

Select the name.

Knob	Operation
[FM]/ [AM]	Change the name.
[◀◀]/ [▶▶]	Change the initial.

5 Make a call

Press the Control knob ([▶▶]) for at least 1 second.

"CALL" or "Call" is displayed.



- To use the Phone Book, it must have been downloaded from the cell-phone. For details, see <Downloading the Phone Book> (page 5).
- Initials including no corresponding name will not be displayed.
- On the control unit that displays three rows, the name in the middle row is the selected one.
- During search, a non-accent character such as "u" is searched for instead of an accent character such as "ü".
- Characters that the control unit cannot display are searched for in the order in which they were registered to the Phone Book.

Dialing by Using the Outgoing Call List

You can dial by using the outgoing call list. Up to ten phone numbers of the originated calls are recorded in the outgoing call list.

1 Enter the outgoing call list mode

Select the "OUT" or "OUT-CALL" display.

Refer to <Selecting the Dialing Mode> (page 7).

2 Select a name or phone number

Push the Control knob towards [FM] or [AM].

3 Make a call

Press the Control knob ([▶II]) for at least 1 second.

"CALL" or "Call" is displayed.



- The outgoing call list is the list of calls originated from this unit. It is not the one stored in the cell-phone memory.
- On the control unit that displays three rows, the phone number in the middle row is the selected one.
- Depending on the type of your control unit, "0" is displayed for the tenth call in the outgoing call list.

Dialing by Using the Incoming Call List

You can dial by using the incoming call list. Up to ten phone numbers of the received calls are stored recorded in the incoming call list.

1 Enter the incoming call list mode

Select the "IN" or "IN-CALL" display.
Refer to <Selecting the Dialing Mode> (page 7).

2 Select a name or phone number

Push the Control knob towards [FM] or [AM].

3 Make a call

Press the Control knob ([▶II]) for at least 1 second.

"CALL" or "Call" is displayed.



- The incoming call list is the list of calls received at this unit. It is not the one stored in the cell-phone memory.
- On the control unit that displays three rows, the phone number in the middle row is the selected one.
- Depending on the type of your control unit, "0" is displayed for the tenth call in the incoming call list.
- Depending on the type of your cell-phone, "+" mark (International call mark) will not be transferred. In this case, the incoming call list cannot be used for making a call.

Functions of the buttons

[SRC] button*

During a call: End the call.

[VOL] buttons*

During a call: Adjusts the voice volume.

[] button

Enters the dialing method selection mode.

When a call comes in: Answers the call.

[▶II] button*

During a call:

Switches between the private talk mode and the hands-free talk mode.

In dialing method selection mode:

Selects a dialing method.

[▶▶] button*

Number dial input: Inputs "+".

[◀◀] button*

Number dial input:

Clears the entered phone number.

[FM] button*

Number dial input: Inputs "#".

[AM] button*

Number dial input: Inputs "**".

[0] – [9] buttons*

Number dial input: Inputs a digit.

[DIRECT] button*

Makes a call.

Remote Control Mode selector switch

Switch to "AUD" when dialing.



- * If your remote controller has a mode selection switch, set it to "AUD".
- Remote controllers with the [] button and/or numeric buttons are available optionally. Purchase a remote controller with a desired function.

Menu System

Set up various functions. The Menu system basic operation method is explained here. The reference for the Menu items and their setting content is after this operation explanation.

1 Enter Menu mode

Press the [MENU] button for at least 1 second.
"MENU" is displayed.

2 Select the menu item

Push the Control knob towards [FM] or [AM].

3 Set the menu item

Push the Control knob towards [◀◀] or [▶▶].

4 Exit Menu mode

Press the [MENU] button.



- Three menu items appear on the display. The menu item displayed at the center is the one you can adjust.

In Standby mode

Selecting the Cell-Phone You Wish to Connect

When two or more cell-phones have already been registered, you need to select the cell-phone you wish to use.

1 Select the phone selection mode

Push the Control knob towards [FM] or [AM].
Select the "Phone Selection" or "PHN-SEL" display.

2 Enter the selected phone selection mode

Press the Control knob ([▶II]) for at least 1 second.
"(name)" is displayed.

3 Select the cell-phone you wish to connect

Push the Control knob towards [FM] or [AM].

4 Set up the cell-phone you wish to connect

Push the Control knob towards [◀◀] or [▶▶].
"* (name)" or "-(name)" is displayed.
"*" (dark color) or "*": The selected cell-phone is busy.
"*" (light color) or "_": The selected cell-phone is on standby.

5 Exit the phone selection mode

Press the [MENU] button.

In Standby mode

Deleting a Registered Cell-Phone

You can delete a registered cell-phone.

1 Select the phone deletion mode

Push the Control knob towards [FM] or [AM].
Select the "Phone Delete" or "PHN-DEL" display.

2 Enter the phone deletion mode

Press the Control knob ([▶II]) for at least 1 second.
"(name)" is displayed.

3 Select the cell-phone you wish to delete

Push the Control knob towards [FM] or [AM].

4 Delete the selected cell-phone

Press the Control knob ([▶II]) for at least 1 second.
"Delete" or "DELETE" is displayed.

5 Exit the phone deletion mode

Press the [MENU] button.



- When a registered cell-phone is deleted, its Phone Book, list of outgoing calls, and list of incoming calls are also deleted.

Displaying the Cell-Phone Status

You can display the connection status, signal strength, and battery level.

1 Select the status display item

Push the Control knob towards [FM] or [AM].
Select the "P-STATUS" display.

2 Enter the status display mode

Press the Control knob ([▶II]) for at least 1 second.

3 Select the item you wish to display

Push the Control knob towards [FM] or [AM].

4 Exit the status display mode

Press the [MENU] button.

If your control unit supports a graphic display function:

1 Select the status display item

Push the Control knob towards [FM] or [AM].
Select the "Phone Status" display.



2 Display the statuses

Push the Control knob towards [◀◀] or [▶▶].
All statuses are indicated with icons.





3 Exit Menu mode

Press the [MENU] button.







Bluetooth connection status

Display	Icon	Information
"BT-CON Y"		Connected
"BT-CON N"		Disconnected

Battery level of cell-phone

Display	Icon	Information
"BAT FULL"		Full
"BAT MID"		⋮
		⋮
"BAT LOW"		Nearly dead
"BAT - - -"		Cannot get information.

Signal strength of cell-phone

Display	Icon	Information
"SGNL MAX"		Maximum
"SGNL MID"		⋮
		⋮
"SGNL LOW"		Minimum
"NO SGNAL"		Outside the service range
"SGNL - - -"		Cannot get information.



- Since the number of steps of the control unit is different from that of the cell-phone, the statuses displayed on the control unit may discord from those displayed on the cell-phone.

In Standby mode

Setting the Time Interval for Automatic Answer

This function automatically answers (responds to) a call after lapse of the preset time interval for automatic answer.

Display	Setting
"Auto Answer: OFF"/ "ANS OFF"	Does not answer the phone call automatically.
"Auto Answer: 0s"/ "ANS 0"	Automatically answers the phone call at once.
⋮	
"Auto Answer: 8s"/ "ANS 8"	Automatically answers the phone call after lapse of 8 seconds (original setting).
⋮	
"Auto Answer: 99s"/ "ANS 99"	Automatically answers the phone call after lapse of 99 seconds.



- If the time set in the cell-phone is shorter than that set in the unit, the former will be used.

In Standby mode

Setting up the Voice Output Speakers

You can specify the voice output speakers.

Display	Setting
"SP Select: Front"/ "SPK FRT"	Outputs voice from the front-left and front-right speakers.
"SP Select: F-R"/ "SPK F-R"	Outputs voice from the front-right speaker.
"SP Select: F-L"/ "SPK F-L"	Outputs voice from the front-left speaker.



- Select the speaker which is further from the microphone in order to prevent howling or echos.

In Standby mode

Setting the Beep of the Incoming Call

You can output a beep from the speaker when a call comes in.

Display	Setting
"Call Beep: ON"/ "C-BP ON"	Beep is heard.
"Call Beep: OFF"/ "C-BP OFF"	Beep is canceled.

Hands-Free Unit control



- 1 Displays the Search for Phone Book screen.
(See the <Calling by Phone Book>, page 15)
- 2 Displays the Out Going Calls screen.
(See the <Redialing>, page 16)
- 3 Displays the Incoming Calls screen.
(See the <Redialing>, page 16)
- 4 Switches between the private and hands-free modes (only when a call in progress).
- 5 Displays the Hands-Free Set Up screen.
(See the <Setting up the Hands-Free Phone>, page 16)
- 6 Enter three phone numbers for quick dialing.
(See the <Quick Dialing>, page 14)
- 7 Enters a phone number.
(See the <When Dialing>, page 14)

- 8 Displays the signal strength.*
The more the number of bar segments, the stronger the signal.
- 9 Displays the present Auto Answering status
When Auto Answering is on: AUTO
When Auto Answering is off:
- 10 Displays the battery drain of the cell-phone.*
The more the number of bar segments, the higher the battery level.
- 11 Starts the call.
- 12 Ends the call.
Clears the phone number being entered.
- 13 Clears the entered phone number.
- 14 Returns to the previous screen.
- 15 Displays the calling and called phone numbers.
If you have registered a phone number in the Phone Book, the destination person name is displayed.
- 16 Displays the status of connection with the cell-phone.
White: The cell-phone is connected.
Orange: The cell-phone is not connected, or it is outside the service range.



- While your car is moving, some functions are disabled for safety's sake. The buttons associated with the disabled functions become ineffective if pressed.
- When the Hands-Free Control screen appears, the name of the connected cell-phone is displayed for 5 seconds.
- * Since the number of steps of the control unit is different from that of the cell-phone, the statuses displayed on the control unit may discord from those displayed on the cell-phone. No status is displayed if information about it cannot be obtained.
- Setting the cell-phone in the private mode can disable the hands-free function.

Remote Controller

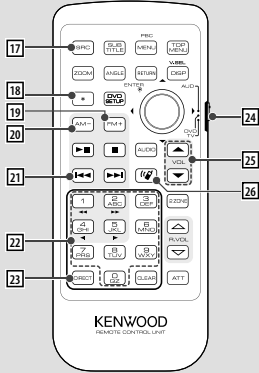

17 [SRC] key

During a call: Ends the call.

18 [*] key (When 24 is set to "AUD")

Number dial input: Inputs "+".

19 [FM+] key (When 24 is set to "AUD")

Number dial input: Inputs "#".

20 [AM-] key (When 24 is set to "AUD")

Number dial input: Inputs "*".

21 [◀◀] key (When 24 is set to "AUD")

Number dial input:

Clears the entered phone number.

22 [0] - [9] key (When 24 is set to "AUD")

Number dial input: Inputs a phone number digit.

23 [DIRECT] key (When 24 is set to "AUD")

Make a call.

24 Remote Control Mode selector switch

Switch to "AUD" when dialing.

25 [▲]/[▼] key

During a call: Adjusts the voice volume.

26 [📞] key

Displays the Hands-Free Control screen.

When a call comes in: Answers the call.



- The voice volume level adjusted during a call will be effective for the next and subsequent calls.
- Increasing the volume excessively is more likely to produce echo. If echo is produced, turn down the volume as low as possible. Echo increases in proportion to the volume.

Key Operation



27 [^]/[v] key

During a call: Adjusts the voice volume.

28 [SRC] key

During a call: Ends the call.

When Called

When you receive a call, you can use the hands-free phone.

1 Responds to a call



When a call arrives, the Hands-Free Control screen appears automatically.

2 End the call



The previous screen reappears.

When Dialing

Make a call by entering a phone number.

1 Enter a phone number

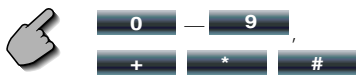

2 Make a call



You can start talking when the destination responds.



- To clear your incorrect entry, touch **Clear**.

3 End the call



The previous screen reappears.



- You can input max 32 digits.

Quick Dialing

You can register up to 3 phone numbers for quick dialing.

To register a phone number:

1 Display a phone number you wish to register

See the <Calling by Phone Book> (page 15), <Redialing> (page 16) and <When Dialing> (page 14).

2 Register the phone number



Continue to touch more than 2 seconds.

To call a phone number from memory:

1 Recall the phone number



2 Make a call



- Only the phone numbers can be registered for Quick Dialing. Therefore, the destination subscriber name and others are not displayed during dialing.

Calling by Phone Book

You can call a person using his/her phone number that you have registered in the Phone Book.

1 Display the Phone Book screen



The Initial Input screen appears.

Initial Input screen



- ① Scrolls the character array display.
- ② Displays the Phone Book beginning with the name whose first character you have touched.
- ③ Returns to the Hands-Free Control screen.

2 Select the initial character of a person name in memory



The Phone Book List screen appears.

Phone Book List screen



- ① Scrolls the list.
- ② Enters the destination name.
- ③ Enters the destination data and returns to the Hands-Free Control screen.
- ④ Returns to the Hands-Free Control screen.

3 Select a destination you wish to call



4 Confirm the destination



The Hands-Free Control screen appears again. The selected destination data is displayed.

5 Make a call



You can start talking when the destination responds.

6 End the call



The previous screen reappears.



- To use the Phone Book, it must have been downloaded from the cell-phone. For more details, see <Downloading the Phone Book> (page 5).
- Up to 16 characters can be displayed for each name in the Phone Book.
- Initials including no corresponding name will not be displayed.
- During search, a non-accent character such as "u" is searched for instead of an accent character such as "ü".

Redialing

You can redial, one of the last 10 phone numbers that you have called or received.

1 Display the Search for Out Going Calls or Incoming Calls screen

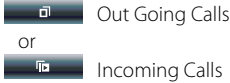

The Out Going Calls or Incoming Calls list screen appears.

Out Going Calls or Incoming Calls screen

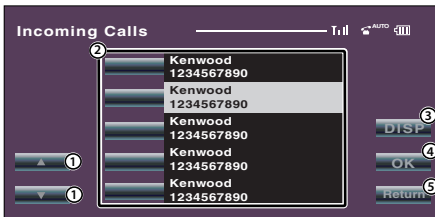

- 1 Scrolls the list.
- 2 Enters the destination name.
- 3 Change to record of redial list.
- 4 Enters the destination data and returns to the Hands-Free Control screen.
- 5 Returns to the Hands-Free Control screen.

2 Select a destination you wish to call



3 Confirm the destination



The Hands-Free Control screen appears again. The selected destination data is displayed.

4 Make a call



You can start talking when the destination responds.

5 End the call



The previous screen reappears.



- The Out Going Calls list screen or Incoming Calls list screen shows the list of the calls originated from or received at this unit. They are not the ones stored in the cell-phone memory.

Setting up the Hands-Free Phone

The Hands-Free system can be set as follows.



Hands-Free Set Up screen

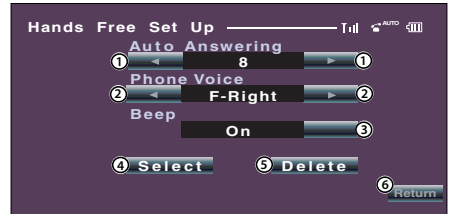

- 1 Sets an automatic response time after call termination. (📄 "8")
"Off": This function can not use.
"0-99": Sets to calling ring time (second).
- 2 Sets a ringing tone output position. (📄 "F-Right")
"F-Left": Outputs the tone from the front left-hand side speaker.
"F-Right": Outputs the tone from the front right-hand side speaker.
"Front All": Outputs the tone from the both front speakers.
- 3 Set the beep of the incoming call. (📄 "On")
"On": Beep is heard.
"Off": Beep is canceled.
- 4 Display the Phone Select screen.
- 5 Display the Phone Delete screen.
- 6 Returns to the Hands-Free Control screen.



- Either the time interval for automatic answer set on this unit or the time interval set on the cell-phone, whichever is shorter, takes effect.
- Select the speaker which is further from the microphone in order to prevent howling or echos.

Selecting a Hands-Free Phone

You can choose the Hands-Free phone from the list.

1 Display the Hands-Free Set Up screen



SetUp

2 Display the Phone Select list



Select

Phone Select screen



- ① Selects the cell-phone to be used as a hands-free phone.
- ② Returns to the Hands-Free Set Up screen.

3 Select a Hands-Free phone you wish to use



Kenwood 1

Deleting the Hands-Free Phone

You can cancel a registration of Hands-Free phone.

1 Display the Hands-Free Set Up screen



SetUp

2 Display the Phone Delete list



Delete

Phone Delete screen



- ① Selects the cell-phone to be deleted from the list.
- ② Returns to the Hands-Free Set Up screen.

3 Select a Hands-Free phone you wish to delete



Kenwood 3



- The Phone Book, outgoing call list, and incoming call list are deleted together with the deleted Hands-Free phone.

Accessories/ Installation Procedure

Accessories

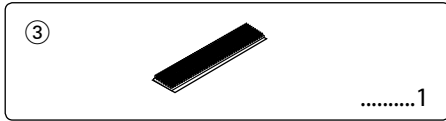
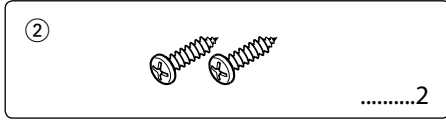
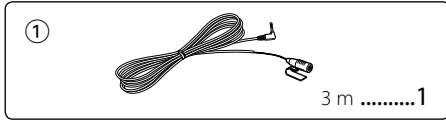

Installation Procedure

1. To prevent a short circuit, remove the key from the ignition and disconnect the ⊖ battery.
2. Set the display character conversion function switch.
3. Make the proper input and output wire connections for each unit.
4. Install the unit in your car.
5. Reconnect the ⊖ battery.
6. Press the reset button on the control unit.



- Insulate unconnected wires with vinyl tape or other similar material. To prevent a short circuit, do not remove the caps on the ends of the unconnected wires or the terminals.
- After the unit is installed, check whether the brake lamps, blinkers, wipers, etc. on the car are working properly.

For Good Reception

To assure good reception, note the following:

- Communicate with the cell-phone within the line-of-sight distance of 10 m. The communication range becomes shorter depending on the surrounding environment. The communication range also becomes shorter when there is an obstacle between this unit and the cell-phone. The above maximum communication range (10 m) is not always assured.
- Keep this unit away from other electric components (AV components) as far as possible. If they are near, call connection can fail, TV or radio noise can be generated, or poor reception can occur.
- A broadcast station or walkie-talkie located nearby can interfere with communication due to too strong signal.

Display Character Conversion Function

If the control unit cannot display accent characters such as "ü" and "ä", set the display character conversion function switch to "2" to convert them to "U" and "A".

When one of the following control units is connected, set the switch to "2". (As of September 2006)

KDV-MP6333, KDV-MP6433, KDC-X7533U, KDC-MP5033U, DPX-MP2090U

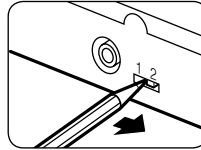

Conversion Table

Conversion character	
A:	Ä, ä, Å, å, Ä, ä, Å, å, Ä, ä, Å, å
C:	Ç, ç
D:	Ð, ð
E:	Ë, ë, É, é, Ê, ê, Ë, ë
I:	Í, í, Î, î, Ï, ï
N:	Ñ, ñ
O:	Ô, ô, Ó, ó, Õ, õ, Ö, ö, Ø, ø
S:	ß
U:	Ü, ü, Ú, ú, Û, û, Ü, ü
X:	×
Y:	Ý, ý, ÿ

Connection

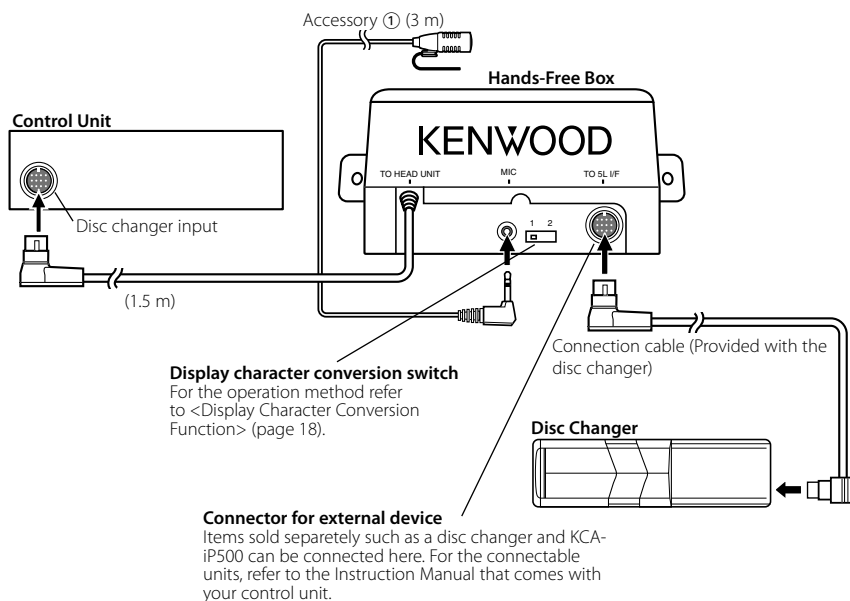

If You Want to Connect KCA-S220A

Connect the Hands-Free Box to the terminal labelled TO CHANGER 2.

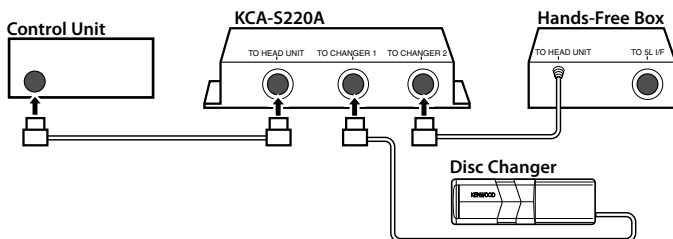

- Please keep the total extension of the control cable from the control unit to the disc changer to 13 m or less. Control cable lengths in excess of 13 m will cease to function properly.

Installation

Installation the Hands-Free Box



- Determine the installation position after making sure that the unit can communicate with the cell-phone.
- Please do not install the unit near the dashboard, the rear tray, or other important components. Doing so could lead to injury or accident should the unit come off due to a shock and strike a person or an important component. Tapping screws should be used for mounting. (Attachment with velcro strips, although easy, can come off with a shock.)

Securing to audio board

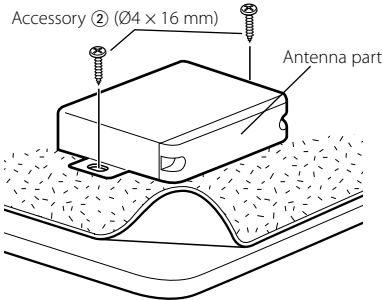

Securing to pile carpet

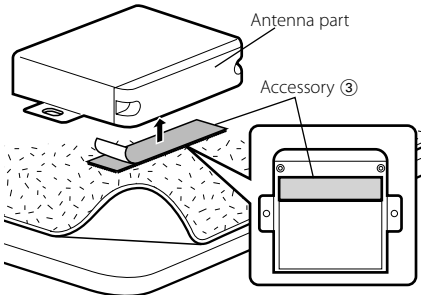

- Do not stick the velcro tape over the serial number.
- If the installation place is stepped, cut the velcro tape into two pieces and stick them at two positions as shown.

Installation the Microphone Unit

- 1 Check the installation position of the microphone (accessory ①).
- 2 Remove oil and other dirt from the installation surface.
- 3 Install the microphone.
- 4 Wire the microphone cable up to the hands-free box with it secured at several positions using tape or the like.

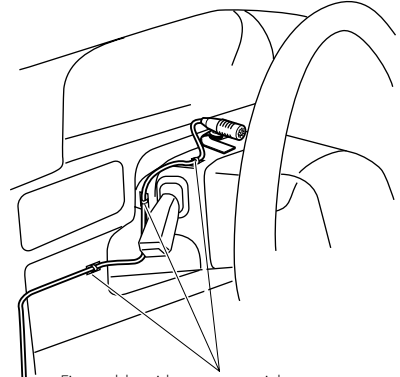

Fix a cable with a commercial item of tape.

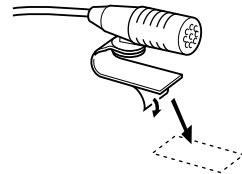

Peel the release coated paper of double-face adhesive tape to fix on the place shown in the left-hand example.

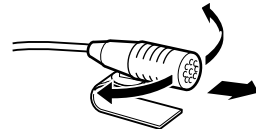

Adjust the direction of the microphone to the driver.

Troubleshooting Guide

What might seem to be a malfunction in your unit may just be the result of slight misoperation or miswiring. Before calling service, first check the following table for possible problems.

? The hands-free talk volume is low.

- ✓ The hands-free talk volume is set at a low level.
 - ☞ The hands-free talk volume can be adjusted independently. Adjust it during hands-free talk.

? No sound is heard from the rear speakers.

- ✓ You are talking in the hand-free talk mode.
 - ☞ No sound is heard from the rear speakers in the hands-free talk mode.

? No beep is heard at reception of an incoming call.

- ✓ No beep is heard depending on the type of your cell-phone.
 - ☞ Selecting "Call Beep: ON" or "C-BP ON" (page 11), or "Beep On" (page 16) allows you to hear the beep.

? Characters in a name are missing.

- ✓ The control unit cannot display accent characters.
 - ☞ Set the display character conversion function switch to "2" (page 18).

? The name of the cell-phone is not displayed.

- ✓ When registering a cell-phone, the address may be displayed instead of the name of the cell-phone.
 - ☞ Turn off the power of the control unit and on again. The name of the connected cell-phone will be displayed.

The messages shown below display your systems condition.

No Number/ NO-NUMBER/ Incoming No Number :

- The calling party does not notify a caller ID.
- There is no phone number data.

No Data/ NO DATA :

- There is no outgoing call list.
- There is no incoming call list.

No Entry/ NO ENTRY :

- The cell-phone has not been registered (pairing).

Disconnect/ DISCONNECT/ Non Connection/ Disconnected :

- The unit cannot communicate with the cell-phone.

Connect/ CONNECT :

- The unit can communicate with the cell-phone.

HF Error 07/ HF ERR07:

- The memory cannot be accessed.
 - ➔ Turn off the power and on again. If this message still appears, press the reset button on the control unit.

HF Error 68/ HF ERR68:

- The unit cannot communicate with the cell-phone.
 - ➔ Turn off the power and on again. If this message still appears, press the reset button on the control unit.

Specifications

Specifications subject to change without notice.

Bluetooth section

- Technology
 - : Bluetooth 1.2 Certified
- Frequency
 - : 2.402 – 2.480 GHz
- Output Power
 - : +4dBm (MAX), 0dBm (AVE) Power Class 2

General

- Operating voltage (11 – 16V allowable)
 - : 14.4 V
- Current consumption
 - : 0.2 A
- Dimension (W × H × D)
 - : 95 × 30 × 105 mm
- Weight
 - : 0.35 kg

KENWOOD